

1. DIMENSION OUTLINE

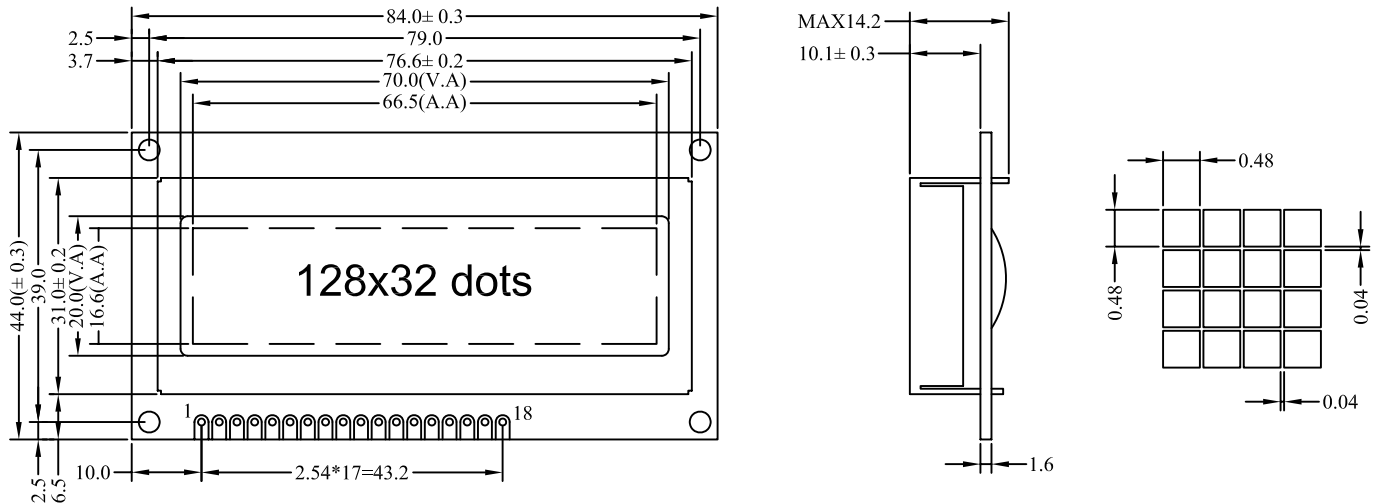

2. MECHANICAL SPECIFICATIONS

ITEM	SPECIFICATIONS	ITEM	REMARK
Module Size(L×W×H)	84.0×44.0×14.2	mm	Reference Dimensional Outline
View Area(W×H)	70.0×20.0	mm	
Effective V/Area	66.5×16.6	mm	
Number of Characters	128×32	-	
Dot Pitch(W×H)	0.52×0.52	mm	
Dot Size(W×H)	0.48×0.48	mm	
Weight (Reflective/Led)	-	g	

3. ABSOLUTE MAXIMUM RATINGS

ITEM	SYMBOL	CONDITION	STANDARD	
			MIN	MAX
Logic Voltage	V _{DD}	Ta=25°C	-0.3V	5.5V
LCD Voltage	V _{LCD}		-0.3V	7V
Input Voltage	V _I		-0.3V	V _{DD} +0.3V
Operation Temperature	T _{OP}	—	-20°C	70°C
Storage Temperature	T _{st}	—	-30°C	80°C

4. BLOCK DIAGRAMMECHANICAL

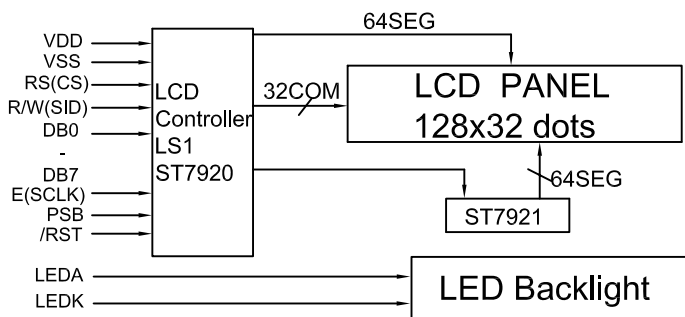

5. LED BACKLIGHT SPECIFICATIONS

ITEM	SYMBOL	TYPE	MAX	UNIT
Ta=25°C				
Forward Voltage	V _f	4.1	4.3	V
Forward Current	I _f	200	—	mA
Emission Wave Length	λ _p	568	—	nm

6. INTERFACE PIN CONNECTIONS

ITEM	SYMBOL	LEVEL	FUNCTIONS
1	VSS	0V	Power Ground
2	VDD	+5V	Power Supply For Logic
3	V0	—	Contrast adjust
4	RS(CS)	H/L	H:data L:command
5	R/W(SID)	H/L	H:read L:write
6	E(SCK)	H.H→L	Enable signal
7-14	DB0-DB7	H/L	Data Bus
15	PSB	H/L	H:Parallel mode L:Serial mode
16	/RST	L	Reset signal
17	LEDA	+5V	Power supply For LED Backlight
18	LEDK	0V	

7. ELECTRICAL CHARACTERISTICS

ITEM	SYMBOL	MIN	TYPE	MAX	UNIT
Ta=25°C					
Logic Power	V _{DD}	4.5	5	5.5	V
Input High Voltage	V _{IH}	0.7V _{DD}	—	V _{DD}	V
Input Low Voltage	V _{IL}	-0.3	—	0.6	V
Output High Voltage	V _{OH}	0.8V _{DD}	—	V _{DD}	V
Output Low Voltage	V _{OL}	0	—	0.4	V
Logic Current	I _{DD}	—	3	5	mA
Operation Voltage For LCD	V _{0-GND}	—	5	—	V