

1.DIMENSION OUTLINE

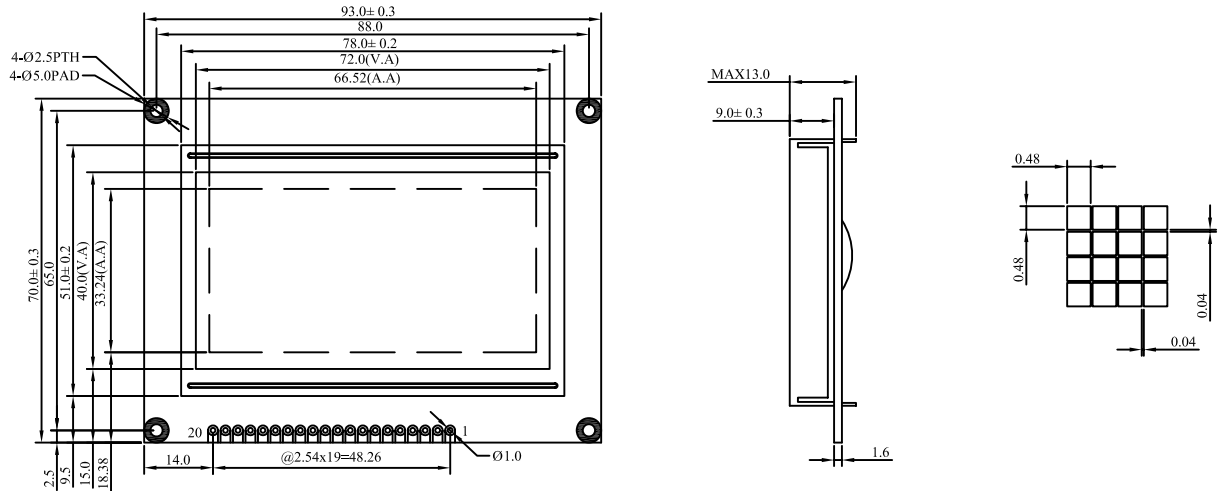

2.MECHANICAL SPECIFICATIONS

ITEM	SPECIFICATIONS	ITEM	REMARK
Module Size(L×W×H)	93.0×70.0×13.0	mm	Reference Dimensional Outline
View Area(W×H)	72.0×40.0	mm	
Effective V/Area	66.52×33.24	mm	
Number of Characters	128×64	-	
Dot Pitch(W×H)	0.52×0.52	mm	
Dot Size(W×H)	0.48×0.48	mm	
Weight (Reflective/Led)	-	g	

3.ABSOLUTE MAXIMUM RATINGS

ITEM	SYMBOL	CONDITION	STANDARD	
			MIN	MAX
Logic Voltage	V _{DD}	Ta=25°C	-0.3V	7V
LCD Voltage	V _{LCD}		-0.3V	17.5V
Input Voltage	V _I		-0.3V	V _{DD} +0.3V
Operation Temperature	T _{OP}	—	-20°C	70°C
Storage Temperature	T _{St}	—	-30°C	80°C

4.BLOCK DIAGRAMMECHANICAL

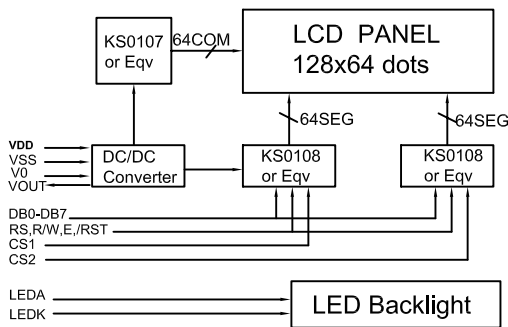

5.LED BACKLIGHT SPECIFICATIONS

ITEM	SYMBOL	TYPE	MAX	UNIT
Ta=25°C				
Forward Voltage	V _f	4.1	4.3	V
Forward Current	I _f	360	—	mA
Emission Wave Length	λ _P	568	—	nm

6.INTERFACE PIN CONNECTIONS

ITEM	SYMBOL	LEVEL	FUNCTIONS
1	VSS	0V	Power Ground
2	VDD	+5V	Power supply for logic
3	V0	—	Contrast adjust
4	RS	H/L	H:data L:command
5	R/W	H/L	H:read L:write
6	E	H.H→L	Enable signal
7-14	DB0-DB7	H/L	Data Bus
15	CS1	H	Chip selection IC1
16	CS2	H	Chip selection IC2
17	/RST	L	Reset signal
18	VOUT	—	Output voltage for lcd driving
19	LEDA	+5V	Power supply for LED backlight
20	LEDK	0V	

7.ELECTRICAL CHARACTERISTICS

ITEM	SYMBOL	MIN	TYPE	MAX	UNIT
Ta=25°C					
Logic Power	V _{DD}	4.5	5	5.5	V
Input High Voltage	V _{IH}	0.8V _{DD}	—	V _{DD}	V
Input Low Voltage	V _{IL}	VSS	—	0.8	V
Output High Voltage	V _{OH}	2.4	—	—	V
Output Low Voltage	V _{OL}	0	—	0.4	V
Logic Current	I _{DD}	—	6	8	mA
Operation Voltage For LCD	V _{DD-V0}	—	10	—	V